

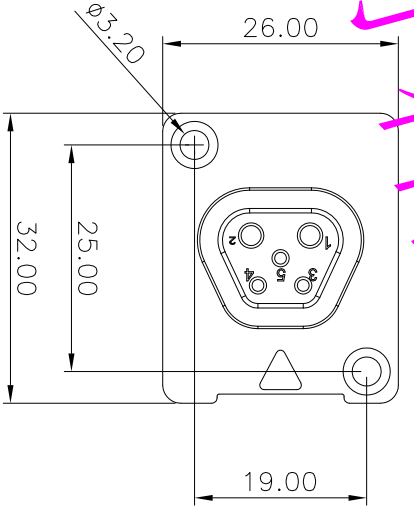

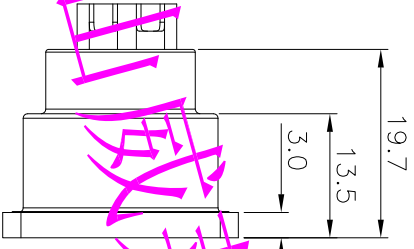

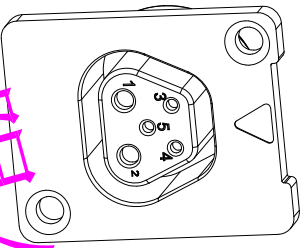

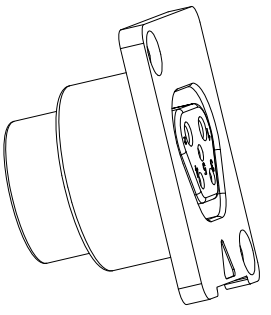
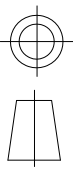

REV	ECOM	DESCRIPTION OR REVISION	修改人	DATE
V01		新图纸		2018.10.20

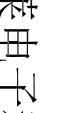

昆山威莱电子科技有限公司

NO	描述	数量	材质
C	PIN 针 2	3	黄铜 IP B59-1
B	PIN 针 1	2	黄铜 IP B59-1
A	塑胶主体	1	增强 PA6 新料 UL-94 V0

 THIRD ANGLE PROJECTION 第三视角画法	 ALL DIMENSION ARE IN mm 单位:mm (UNLESS OTHERWISE SPECIFIED)	 ANGULAR 角度公差	 SCALE 比例	 SHEET 页码	 TITLE: 品名	 APPROVAL: 核准	 PART NO: 料号
X ±0.30 XX ±0.20 XXX ±0.15	X° ±2° XX° ±1° XXX° ±0.5°	FIT	10A 五芯梯形防水电池充电口母座	10F-1	10A 五芯梯形防水电池充电口母座	David 2018/10/20	WL-078
X XX XXX	X.X° X.XX°	FIT	10A 五芯梯形防水电池充电口母座	10F-1	10A 五芯梯形防水电池充电口母座	David 2018/10/20	WL-078
X XX XXX	X.X° X.XX°	FIT	10A 五芯梯形防水电池充电口母座	10F-1	10A 五芯梯形防水电池充电口母座	David 2018/10/20	WL-078

W

昆山威莱电子科技有限公司